

Optical Cage System - a family of modular components

OptoSigma Cage System - ideal for a variety of prototyping and/or research!

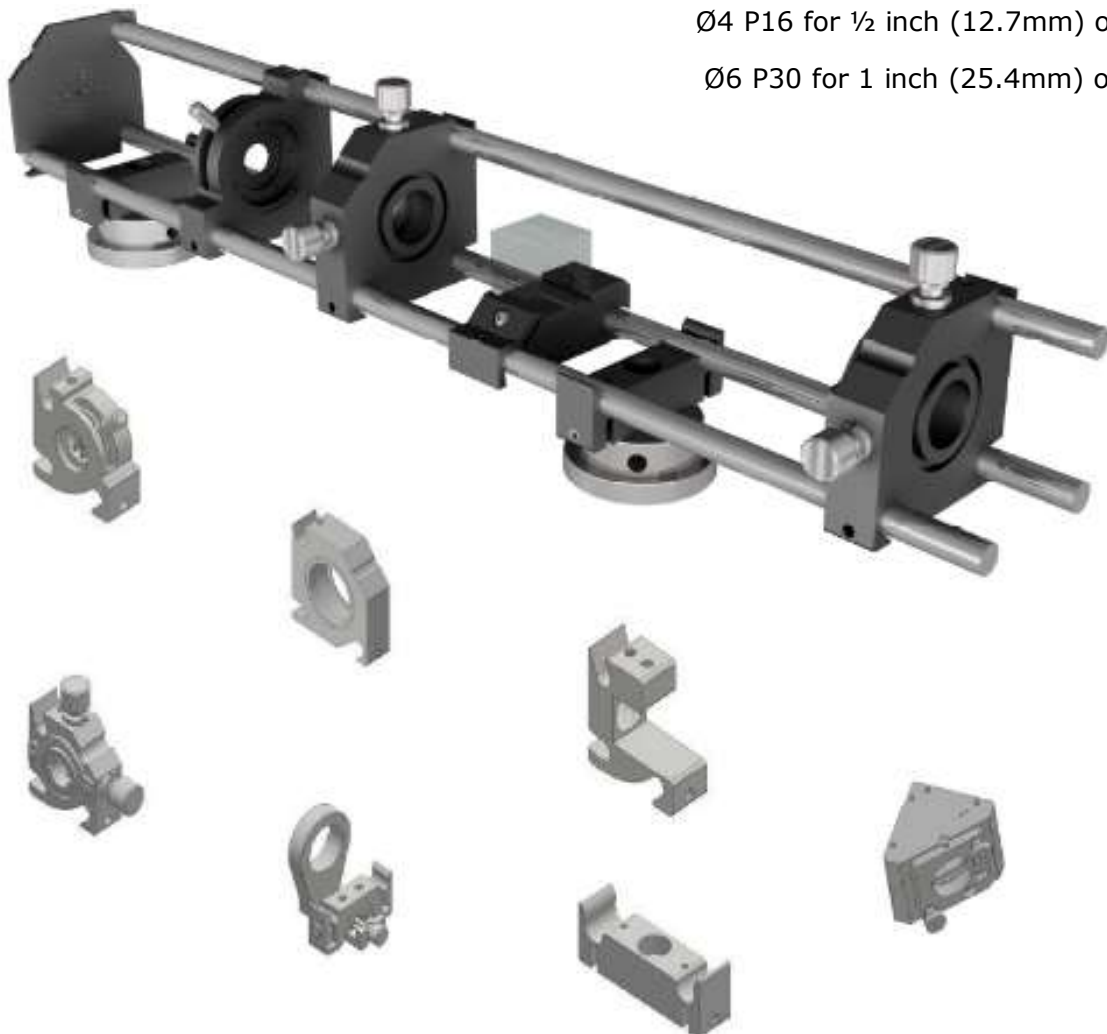











The Cage System is a new series of products creating a system for a variety of mechanical component and optical setups, which allows a versatile range of integrated optical structures to be built using a rigid, easy to assemble, align and adapt according to your individual study - framework of an extensive selection of holders.

The cage system uses three steel rods along a common optical axis. Optical components can be mounted, flexible to your individual purpose. A variety of holders are available for mounting mirrors, lens, polarizers, beam splitter cubes and C-mount cameras. There are two sizes available, the P16 (16mm pitch between the rods) for ½ inch (12.7mm) optics and the P30 (30mm pitch between the rods) for 1 inch (25.4mm) optics.





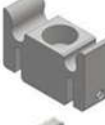











Ø4 P16 for ½ inch (12.7mm) optics

Ø6 P30 for 1 inch (25.4mm) optics

P16 for ½ inch (12.7mm) optics	Cage Post Dia. (mm) Ø4
P/N	Description
	NDK-016-38-01-Ø4-(20~300)
C16-RO-4-20	Cage Rod, Length 20 (mm)
C16-RO-4-30	Cage Rod, Length 30 (mm)
C16-RO-4-50	Cage Rod, Length 50 (mm)
C16-RO-4-100	Cage Rod, Length 100 (mm)
C16-RO-4-155	Cage Rod, Length 155 (mm)
C16-RO-4-200	Cage Rod, Length 200 (mm)
	NDK-016-29-127
C16-SMH-12.7	Slot in Mirror Holder (12.7)
	NDK-016-30-127
C16-SLH-12.7	Slot in Lens_Filter Holder (12.7)
	NDK-016-31-127
C16-SLH-12.7A	Slot in Lens_Filter Holder (12.7) Thick
	NDK-016-20-1-127
C16-AMH-12.7	Right angle mirror holder (12.7)
	NDK-016-21-127
C16-PH-12.7	Polarizer Holders (12.7)
	NDK-016-26-127
C16-LHC-10	Two-axis Holder (12.7)
	NDK-016-23-127
C16-IH-8	Iris Diaphragm Holders (12.7)
	NDK-016-24-127-01
C16-PLH-10	prism Holders (15)
	NDK-016-34-25-05-1
C16-TGH-**	Alignment Holders (12.7)
	NDK-016-34-25-05-1
C16-BP-25-12.7	Base Plate25_ (12.7)
	NDK-016-35-01
C16-RMB	Rod mounting base (12.7)
	NDK-016-35-1-01
	Rod mounting base (12.7)

P30 for 1 inch	(25.4mm) optics	Cage Post Dia. (mm) Ø6
	P/N	Description
	C30-RO-6-20	NDK-016-20-01-Ø6-(20~300) Cage Rod, Length 20 (mm)
	C30-RO-6-30	Cage Rod, Length 30 (mm)
	C30-RO-6-50	Cage Rod, Length 50 (mm)
	C30-RO-6-100	Cage Rod, Length 100 (mm)
	C30-RO-6-155	Cage Rod, Length 155 (mm)
	C30-RO-6-200	Cage Rod, Length 200 (mm)
	C30-RO-6-300	Cage Rod, Length 300 (mm)
	C30-SMH-25.4	NDK-016-29-254 Slot in Mirror Holder (25.4)
		C30-SLFH-25.4
C30-SLFH-25.4A		NDK-016-31-254 Slot in Lens_Filter Holder (25.4) Thick
	C30-MAD-25.4-12.7	NDK-016-29-254_127ADP Mirror adapter (25.4-12.7)
	C30-MAD-30-12.7	NDK-016-29-30_127ADP Mirror adapter (30-12.7)
	C30-SLHO-20.32	NDK-016-32-40 Slot in Objective Holder (20.32×0.706)
	C30-SLHO-26	NDK-016-32-02-40 Slot in Objective Holder (26×0.706)
	C30-AMH-25.4	NDK-016-20-1 Right angle mirror holder (25.4)
	C30-PH-25.4	NDK-016-21 Polarizer Holders (25.4)
	C30-LHC-15	NDK-016-26 Two-axis Holder
	C30-OAD—M15.85-M20.32	NDK-016-27 Object adapter (M15.85_M20.32×0.706)

	C30-IH-15	NDK-016-23 Iris Diaphragm Holders (25.4)
	C30-PLH-15	NDK-016-24-01 prism Holders (15)
	C30-PLH-20	NDK-016-24-03 prism Holders (20)
	C30-PAD-15	NDK-016-24-02 prism Holders (15-1)
	C30-TGH-25	NDK-016-25-01 Alignment Holders (25.4)
	C30-TBP	NDK-016-28-1 Cage Z axis stage
	C30-TBP-LHO-20.32	NDK-016-28-2 Objective lens holder (25.4)
	C30-BP-40-25.4	NDK-016-34-40-05-1 Base Plate40_ (25.4)
	C30-BP-40-20.32	NDK-016-34-40-03-1 Base Plate40_ (Objective20.32)
	C30-BP-40-26	NDK-016-34-40-04-1 Base Plate40_ (Objective26)
	C30-BP-40-H35	NDK-016-34-40-01-1 Base Plate40_ (Large diameter)
	C30-BP-40-H30.5	NDK-016-34-40-02 Base Plate40_ (Tube)
	C30-RMB	NDK-016-35-02 Rod mounting base (25.4)
		NDK-016-35-1-02 30 mm adapter



C30-RPCP-30-16	NDK-016-36-01 Rod pitch conversion plate (16-30)
C30-SCMP-H32	NDK-016-33 Slot-in type C mount mounting plate
C30-CMA-25.4-INT	NDK-016-33-02ADP_Int Camera mounting adapter_Int
C30-CMA-25.4-EXT	NDK-016-33-02ADP_Ext Camera mounting adapter_Ext
C30-CB	Cage Cube
C30- J H-25.4	Gimballed Mount
C30-KH-25.4	Kinematic Mount

